

Special toe for ISO-containers

Product number 91 999 060-B

Weight 1.1kg

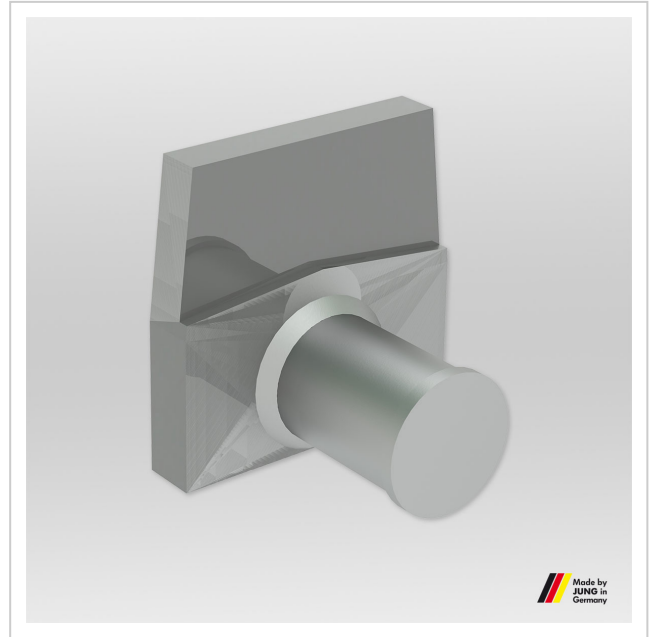

Product description

Toe for Hydraulic Jack JH 15 G plus suitable for Corner Castings of ISO-Container

Product properties

Dimensions (H x W x L mm) 87 x 80 x 90

More images

